

USER'S MANUAL

TwinFresh Easy Digital V2



Heat regeneration single-room reversible ventilator

CONTENTS

Safety requirements.....	2
Purpose.....	4
Delivery set.....	4
Designation key.....	4
Technical data.....	5
Design and functioning	6
Mounting and set-up.....	8
Connection to power mains	11
Technical maintenance.....	16
Troubleshooting.....	17
Storage and transportation requirements.....	17
Manufacturer's warranty.....	18
Certificate of acceptance.....	19
Seller information.....	19
Installation certificate.....	19
Warranty card.....	19

This user's manual is a main operating document intended for technical, maintenance, and operating staff.

The manual contains information about purpose, technical details, operating principle, design, and installation of the TwinFresh Easy (-D) Digital V2 unit and all its modifications.

Technical and maintenance staff must have theoretical and practical training in the field of ventilation systems and should be able to perform works in accordance with workplace safety rules as well as construction norms and standards applicable in the territory of the country.

The information in this user's manual is correct at the time of the document's preparation.

The Company reserves the right to modify the technical characteristics, design, or configuration of its products at any time in order to incorporate the latest technological developments.

No part of this publication may be reproduced, stored in a retrieval system, or transmitted, in any form or by any means in any information search system or translated into any language in any form without the prior written permission of the Company.

SAFETY REQUIREMENTS

- Please read the user's manual carefully prior to installing and operating the unit.
- All user's manual requirements as well as the provisions of all the applicable local and national construction, electrical, and technical norms and standards must be observed when installing and operating the unit.
- The warnings contained in the user's manual must be considered most seriously since they contain vital personal safety information.
- Failure to follow the rules and safety precautions noted in this user's manual may result in an injury or unit damage.
- After a careful reading of the manual, keep it for the entire service life of the unit.
- While transferring the unit control, the user's manual must be turned over to the receiving operator.

UNIT INSTALLATION AND OPERATION SAFETY PRECAUTIONS



- Disconnect the unit from power mains prior to any installation operations.



- Unpack the unit with care.



- Do not lay the power cable of the unit in close proximity to heating equipment.



- While installing the unit, follow the safety regulations specific to the use of electric tools.

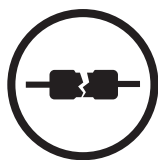

- Do not use damaged equipment or cables when connecting the unit to power mains.



- Do not touch the unit controls with wet hands. Do not carry out the installation and maintenance operations with wet hands.



- Do not allow children to operate the unit.



- Do not store any explosive or highly flammable substances in close proximity to the unit.



- Do not open the unit during operation.



- Do not block the air duct when the unit is switched on.

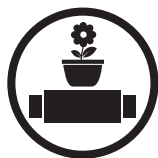

- Do not sit on the unit and avoid placing foreign objects on it.



- Do not operate the unit outside the temperature range stated in the user's manual. Do not operate the unit in aggressive or explosive environments.

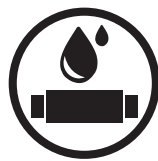

- Do not wash the unit with water. Protect the electric parts of the unit against ingress of water.



- Disconnect the unit from power mains prior to any technical maintenance.



- When the unit generates unusual sounds, odour, or emits smoke, disconnect it from power supply and contact the Seller.



- Do not direct the air flow produced by the unit towards open flame or ignition sources.



- In case of continuous operation of the unit, periodically check the security of mounting.



- Use the unit only for its intended purpose.



**THE PRODUCT MUST BE DISPOSED SEPARATELY AT THE END OF ITS SERVICE LIFE.
DO NOT DISPOSE THE UNIT AS UNSORTED DOMESTIC WASTE.**

PURPOSE

The ventilator is designed to ensure continuous mechanical air exchange in flats, cottages, hotels, cafés and other domestic and public premises. The ventilator is equipped with a regenerator that enables supply of fresh filtered air heated by means of extract air heat energy recovery. The ventilator is designed for wall flush mounting. The unit is rated for continuous operation.



THE UNIT SHOULD NOT BE OPERATED BY CHILDREN OR PERSONS WITH REDUCED PHYSICAL, MENTAL, OR SENSORY CAPACITIES, OR THOSE WITHOUT THE APPROPRIATE TRAINING.

THE UNIT MUST BE INSTALLED AND CONNECTED ONLY BY PROPERLY QUALIFIED PERSONNEL AFTER THE APPROPRIATE BRIEFING.

THE CHOICE OF UNIT INSTALLATION LOCATION MUST PREVENT UNAUTHORIZED ACCESS BY UNATTENDED CHILDREN.

Transported air must not contain any flammable or explosive mixtures, evaporation of chemicals, sticky substances, fibrous materials, coarse dust, soot and oil particles or environments favourable for the formation of hazardous substances (toxic substances, dust, pathogenic germs).

DELIVERY SET

Name	Quantity
Air duct	1 pc.
Sound absorbing material	1 pc.
Cartridge	1 pc.
Indoor unit	1 pc.
Ventilation hood	1 pc.
Control panel	1 pc.
Remote control	1 pc.
Fixing set	1 packing
Mounting box	1 pc.
User's manual	1 pc.
Packing box	1 pc.

TECHNISCHE DATEN

The unit is rated for indoor application with the ambient temperature ranging from -15 °C (5 °F) up to +40 °C (104 °F) and relative humidity up to 50 %.

The unit is rated as a class II electric appliance and must not be grounded.

Ingress Protection (IP) rating from solid objects and liquids IP24.

The unit design is constantly being improved, thus some models may be slightly different from those described in this manual.

The air duct length depends on the unit model (refer to the designation key, page 4).

Speed	TwinFresh Easy Digital V2		
	I	II	III
Supply voltage 50(60) Hz [V]	1~100-240		
Power consumption [W]	1,00	2,1	4,3
Total current consumption [A]	0.017	0.025	0.041
RPM [min ⁻¹]	915	1555	2330
Air capacity in ventilation mode [m ³ /h] (CFM)	15 (9)	30 (18)	50 (29)
Air capacity in regeneration mode [m ³ /h] (CFM)	8 (4)	15 (9)	25 (15)
Filters	G3 (option F8)		
Transported air temperature [°C] (°F)	-15 (+5) bis +40 (+105)		
Sound pressure level @ 1 m [dBA(Sones)]	21 (0,5)	27 (0,7)	29 (1,0)
Sound pressure level @ 3 m [dBA(Sones)]	12 (0,3)	18 (0,4)	20 (0,5)
Outdoor noise level attenuation [dBA (Sones)]	41 (2,5)		
Heat recovery efficiency [%]	≤92		

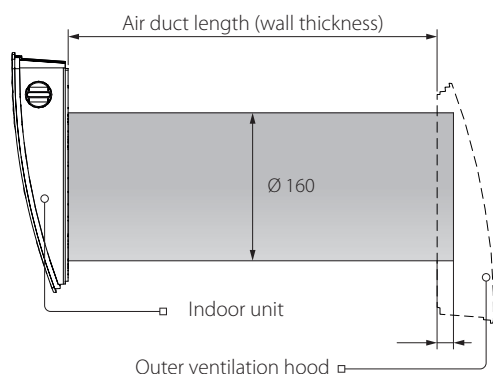

Air duct length

TwinFresh Easy Digital V2	250(150*)-500 (10"(6")-20")
Vento Eco2 A50-4 L Pro1	250 (150*)-700 (10"(6")-28")

* Minimum air duct length with the hood for thin walls AH-S

The ventilation hood model depends on the unit model. The overall dimensions of the outer ventilation hood and the A distance are stated in the mounting instruction for the outer hood.

The overall dimensions of the front panel see below.

OVERALL DIMENSIONS OF THE INDOOR UNIT [MM] (INCH)

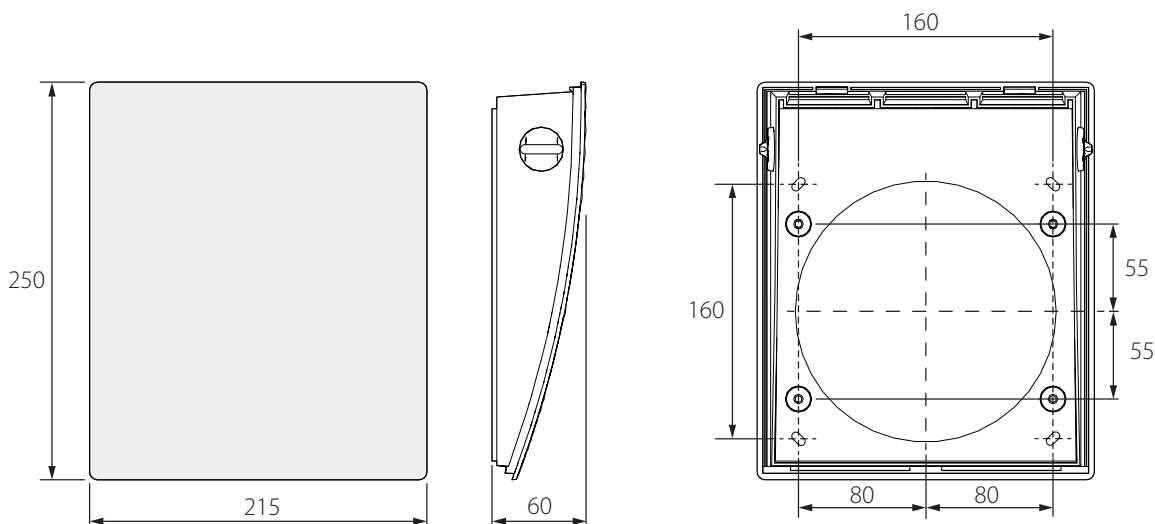

DESIGN AND FUNCTIONING

The ventilator consists of an indoor assembly unit with a decorative front panel, a cartridge, an air duct with a sound absorbing mat and an outer ventilation hood.

Cartridge is the basic functioning part of the unit. It consists of a fan, a regenerator and two filters that ensure primary air filtration and prevent ingress of dust and foreign objects into the regenerator and the fan.

The indoor unit is equipped with a manually operated rotary air damper.

Attention! During closing of air damper the ventilator continues to run, but the air flow is closed.

The protecting grille or ventilation hood must be installed on the outer wall to prevent ingress of water and foreign objects into the ventilator.

VENTILATOR DESIGN

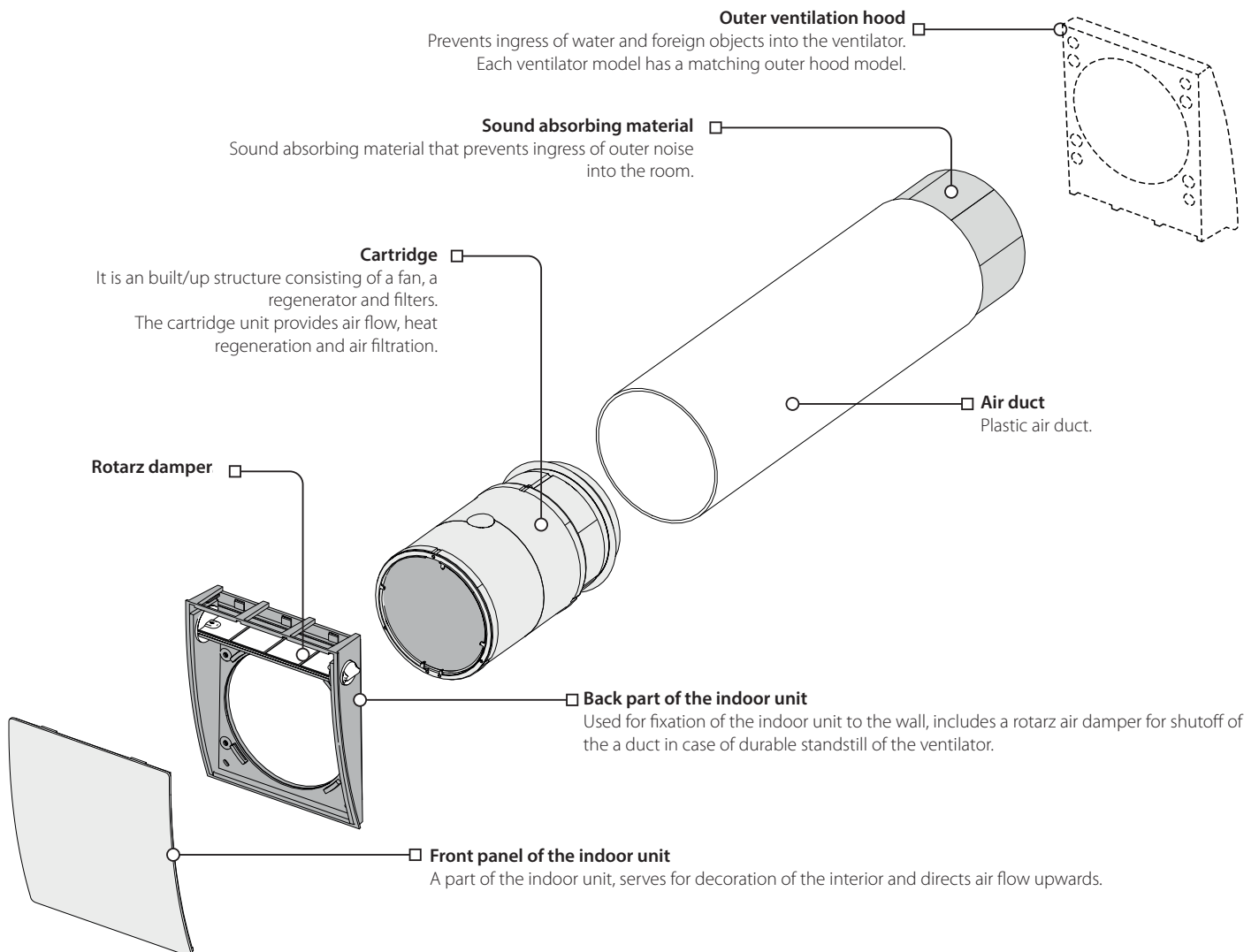

VENTILATOR OPERATION MODES

The ventilator has two operation modes:

Ventilation mode. The ventilator operates in the air supply or air extract mode at set speed.

In this mode in case of installation of two ventilators one ventilator supplies air to the room and the other one extracts used air.

Regeneration mode. The ventilator operates cyclically in two cycles, 70 seconds each, with heat and humidity recovery.

- **Cycle I.** Warm stale air is extracted from the room. As it flows through the regenerator, it heats and moisturizes the regenerator, transferring heat and air moisture. 70 seconds after the ceramic regenerator starts to get warmed the ventilator is switched to the air supply mode.
- **Cycle II.** Fresh intake air from outside flows through the ceramic regenerator and absorbs accumulated moisture and heat up to the room temperature. In 70 seconds, after cooling of the ceramic regenerator, the ventilator is switched to the air extract mode and the cycle is renewed. In this mode in case of installation of two ventilators they run in opposite directions. One ventilator supplies air to the room and the other one extracts used air.

MOUNTING AND SET-UP



READ THE USER'S MANUAL BEFORE INSTALLING THE UNIT.

INSTALLATION OF WALL-MOUNTED CONTROL PANEL



**MAKE SURE THAT THE CONTROL PANEL IS NOT MANAGED.
DO NOT USE A DAMAGED CONTROL PANEL! DO NOT INSTALL THE CONTROL PANEL
ON AN UNEVEN SURFACE! WHEN TIGHTENING THE SCREWS DO NOT APPLY EXCESSIVE
FORCES TO AVOID THE UNIT DEFORMATION.**

Installation of the control panel with LCD display

1. Prepare a wall opening, lay required wires and cables to the installation place of the control panel and install the mounting box for wall flush mounting. The mounting box is included in the delivery set.
2. Unfasten gently the latches on the lower part of the control panel using a screwdriver and disconnect the front part from the back side. Do not disconnect the connectors on the circuit boards in the casing.
3. Connect the wires to the terminal blocks on the back side of the control panel in compliance with external wiring diagrams. Fix the back side of the control panel on the mounting box through the fastening holes with supplied screws.
4. Press the control panel to the frame to click to fix it with latches.

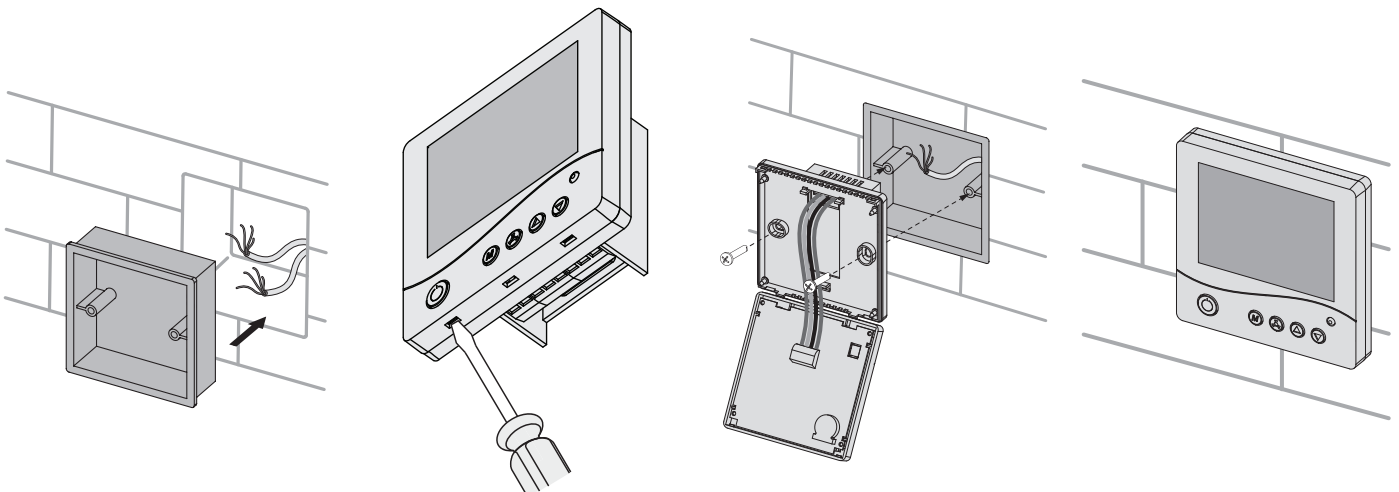

VENTILATOR MOUNTING



READ THE USER'S MANUAL BEFORE INSTALLING THE UNIT.



DO NOT BLOCK THE AIR DUCT OF THE INSTALLED UNIT WITH DUST ACCUMULATING MATERIALS, SUCH AS CURTAINS, CLOTH SHUTTERS, ETC. AS IT PREVENTS AIR CIRCULATION IN THE ROOM.

1. Prepare core holes in the outer wall.

Prepare one or two round core holes in the outer wall depending on ventilation system configuration. To attain efficient ventilation the installation places of the ventilators must be located as far from each other as possible. While preparing core holes it is recommended to make preparations for layout of the power cable and other required cables in the wall. The hole size and minimum distance to the surface, e.g. wall, ceiling or window and the minimum distance between the ventilators is shown below.

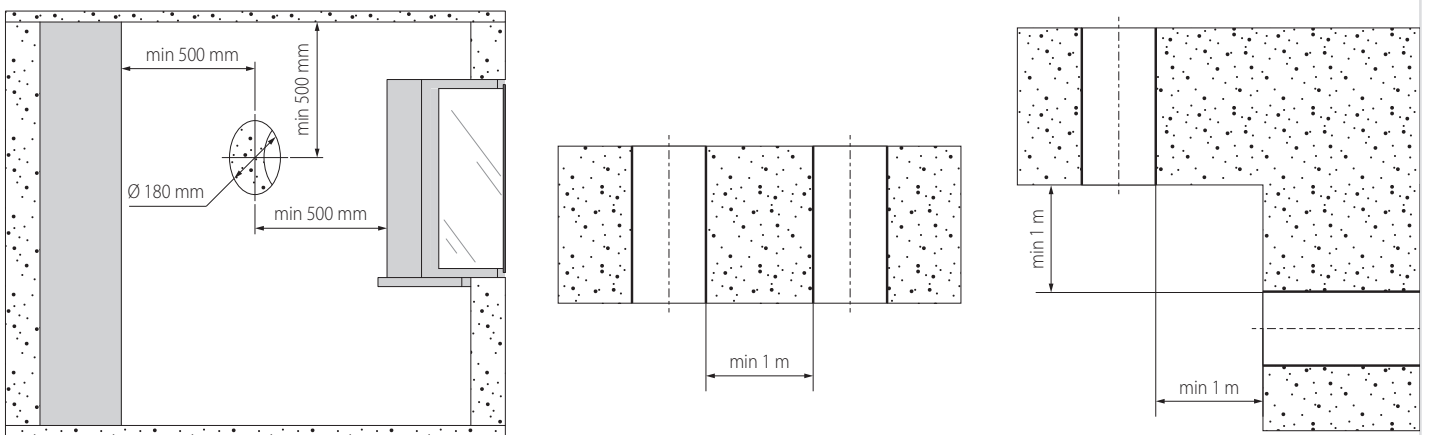

2. Measure the air ducts of the required length.

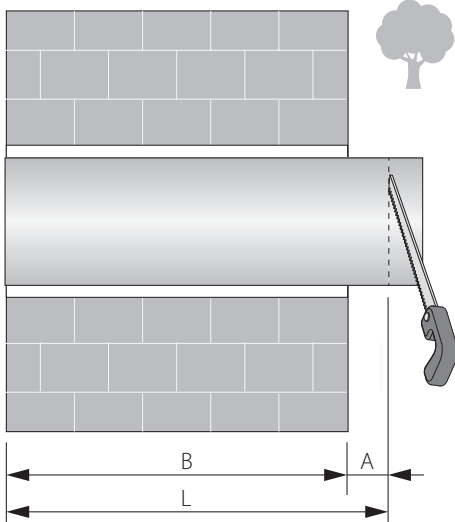

Measure the wall thickness B.

The required air duct length is calculated as $L = B + A$.

A means the projected part of the air duct to the outside required for installation of the outer ventilation grille or hood.

A distance is stated in the installation instruction to the ventilation hood.

Cut air duct to the length L.

3. Insert the sound absorbing roll in the air duct.

	<p>Before inserting the sound absorbing mat adjust its length with respect to dimensions of the cartridge, indoor unit and ventilation hood. Insert the cartridge during adjustment in the air duct and close it with the internal grille. Roll the sound absorbing mat to match the air duct diameter with the protecting paper layer outside. Insert the roll in the air duct against stop to the cartridge. Do not remove the paper layer!</p>
	<p>Ventilator with outer grille Mark the point 1 on the sound absorbing mat on the level of the air duct edge. Starting from the point 1 draw a line for 50 mm (2") and mark the line 2. Cut out the excessive part of the sound absorbing mat. Insert the adjusted sound absorbing roll in the air duct. Do not use any adhesives for fixation.</p>
	<p>Ventilator with outer hood (optionally) Mark the point 1 on the sound absorbing mat on the level of the air duct edge. Cut out the excessive part of the sound absorbing mat. Insert the adjusted sound absorbing roll in the air duct. Do not use any adhesives for fixation.</p>

4. Install the air duct in the wall.

	<p>Install the air duct with the minimum slope of 3 mm downwards to the outer wall side using the polystyrene wedges. Fill the gap between the air duct and the opening with mounting foam.</p>
--	---

5. Route the cable through the cable hole and fix the back part of the indoor unit. Insert the cartridge in the air duct. Disconnect the connector on the cartridge wire and connect the wires from the control panel to the mating part in compliance with the wiring diagram in page 12. Connect the terminal block parts.

--

6. Mount the front panel of the indoor unit and fix the outer ventilation hood.

--

For mounting guidelines please refer to the installation instruction for the outer hood.

CONNECTION TO POWER MAINS



**POWER OFF THE POWER SUPPLY PRIOR TO ANY OPERATIONS WITH THE UNIT.
THE UNIT MUST BE CONNECTED TO POWER SUPPLY BY A QUALIFIED ELECTRICIAN.
THE RATED ELECTRICAL PARAMETERS OF THE UNIT ARE GIVEN ON THE
MANUFACTURER'S LABEL.**



**ANY TAMPERING WITH THE INTERNAL CONNECTIONS IS PROHIBITED
AND WILL VOID THE WARRANTY.**

The ventilator is rated for connection to single-phase ac 100-240 V/ 50 (60) Hz power mains.

For electric installations use insulated durable heat-resistant conductors (cables, wires) with the minimum wire cross section 0.5 - 0.75 mm² via an external automatic circuit breaker installed at the power input. The circuit breaker trip current must be selected in consideration of the ventilator current consumption (refer to table at page 5).

The conductor cross section value must be selected on the wire type, maximum permissible heating temperature, insulation, length and installation method.

Selection of the signal cable must be based on the following criteria:

- Always use shielded cables.
- Wire cross section depends on the length and is selected according to the table below

Cable length [m]	Minimum wire cross section in the cable [mm ²]
< 5	0,25
< 10	0,5
< 15	0,75
< 30	1,5

- Route the signal cable in compliance with respective electrotechnical norms and standards.
- Connect the signal cable screen to the terminals "-" of the control panel and the fan. Use only copper wires for all electric wirings!
- Electrical connections of the ventilator must be completed in compliance with wiring diagrams.

WIRING DIAGRAM FOR THE VENTILATOR WITH CONTROL PANEL WITH LCD DISPLAY

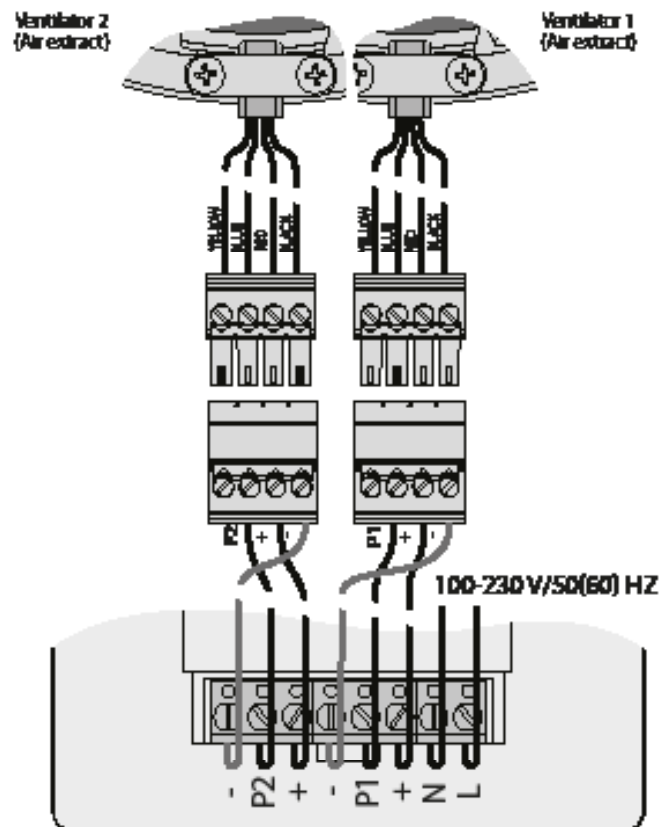

VENTILATOR CONTROL

The ventilator is controlled via the control panel.

These parameters are editable with the control panel:

- ventilator speed stage: low, medium, high
- Regeneration or Ventilation operation mode
- timer-based ventilator operation: 4 hours at the high speed or 8 hours at the low speed.

The display shows the parameters:

- current speed
- current operation mode
- timer operating status (ON/OFF)
- filter replacement/servicing need according to the filter timer (factory setting 90 days)
- ventilator alarm shutdown in case of motor malfunction

In the event of de energizing of the ventilator the set parameters are saved in the non-volatile memory of the control panel.

UNIT CONTROL USING THE BUTTONS ON THE LCD

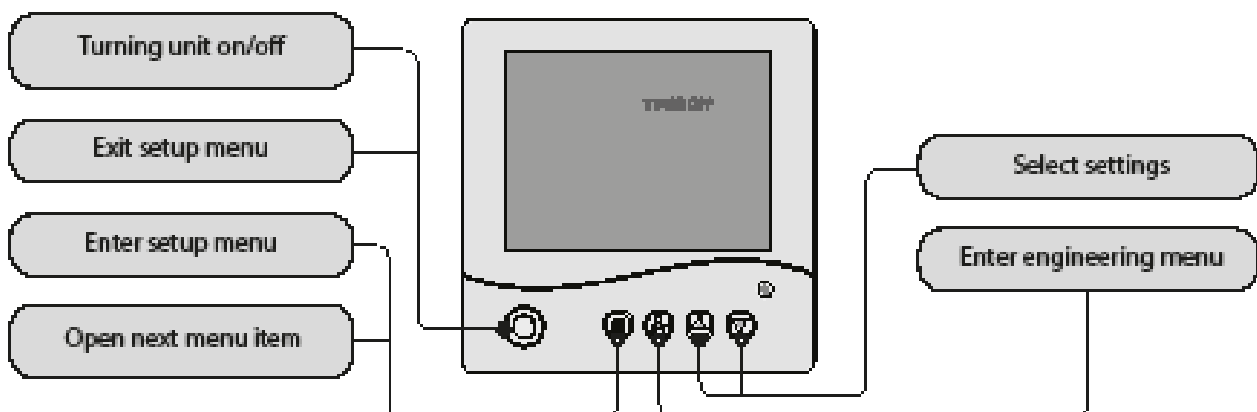

1. Turning ventilator on.

Connect the ventilator to power supply. The display shows the timer operating status.

Press the button to turn the ventilator on.

The display shows current speed, active operation mode and timer operating status.

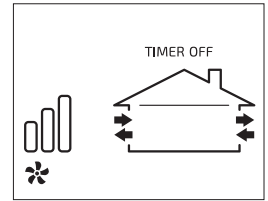

2. User menu

To navigate between the user menu items press consistently the button.

- speed
- timer
- operation mode
- engineering menu

3. Parameter setting in the user menu.

speed

Parameter setting using the or buttons:

low speed

middle speed

high speed

timer

Parameter setting using the or buttons.

4 hours at the high speed **H : SP : 4h** TIMER ON

8 hours at the low speed **Lo : SP : 8h** TIMER ON

turning timer off **TIMER OFF**

The ventilator reverts to operation with a previous speed setting upon countdown of the set time period.

operation mode

Parameter setting using the or buttons.

Regeneration mode

Ventilation mode

In case of installation of two ventilators the air flow direction depends on the external wiring, refer the wiring diagram on the page 12.

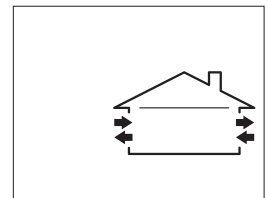
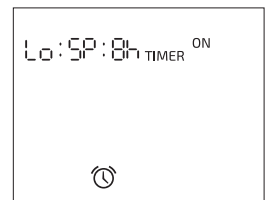

4. Engineering menu

Press the button to go to engineering menu .

To navigate between the engineering menu items press consistently the button.

- F.L** filter servicing timer
- 1 r 2** configuration
- SLEEP** deactivation mode
- TYPE** speed setting

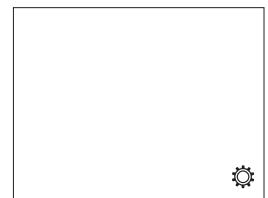

5. Parameter setting in the engineering menu.

FIL filter servicing timer

The serviced hour number is displayed. To reset the filter servicing timer press and hold the  button for 4-5 seconds.

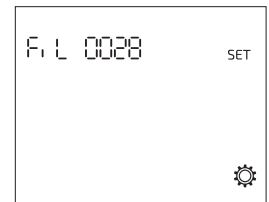

lor2 configuration

Parameter setting using the  or  buttons.

One ventilator 1.

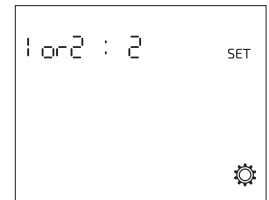
Two ventilators 2.



SLEEP deactivation mode

Parameter setting using the  or  buttons.

ON: user can turn the ventilator off.

OFF: user cannot turn the ventilator completely off, the ventilator will run at the permanent low speed.



LYPE speed setting

Parameter setting using the  or  buttons.

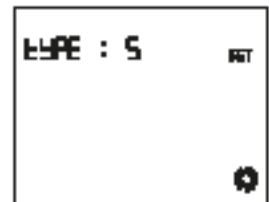
Set the value 5.



6. Return to user menu.

Press several times the  button till the main window of the user menu is displayed. Automatic reset to the main window is performed 20 seconds after the button on the control panel was pressed last time.

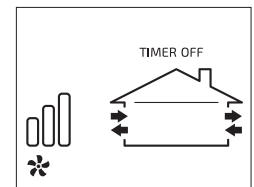

7. Alarm indicator.

 indicator is displayed during motor alarm.

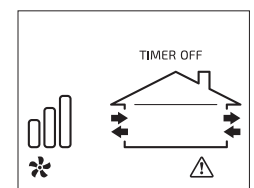

8. Ventilator turning off.

To turn the ventilator off go to the main window and press the  button. If the timer was on, the ventilator turns off only after complete countdown of the set time. To set the ventilator operation in the off status start from the point 2.

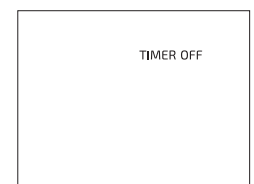

REMOTE VENTILATOR CONTROL

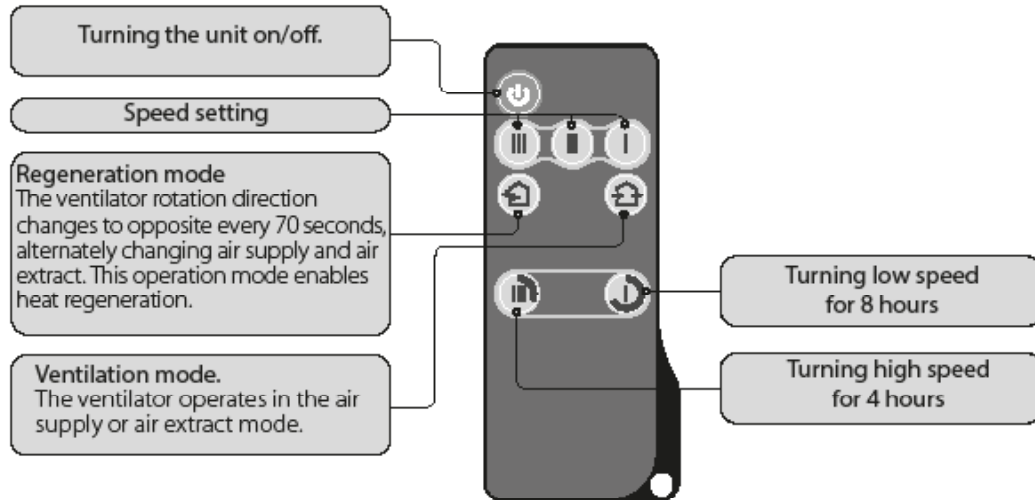

	Turning ventilator on/off
	Ventilator speed setting: high-medium-low speed respectively
	Regeneration mode. The ventilator runs 70 seconds in the supply mode and the next 70 seconds in the extract mode with heat regeneration.
	Ventilation mode. The ventilator runs exclusively in the supply or extract mode. In case of installation of two ventilators the air flow direction depends on the external wiring, refer the wiring diagram on the page 12.
	Timer control settings: : 4 hours at the high speed. : 8 hours at the low speed. After completing the set countdown the ventilator reverts to operation with previous speed settings. Press any manual speed button to turn the timer off.

CLOSING AIR DUCT

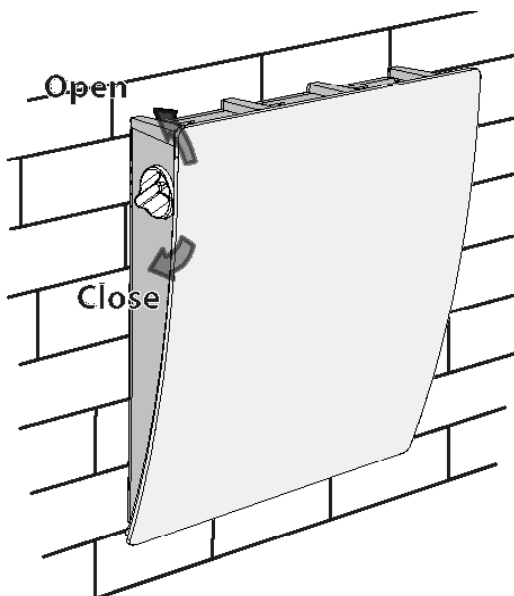

The indoor unit is equipped with a rotary air damper. To open or close the air duct turn one of the levers on the side walls of the indoor unit against stop, as shown below. The vertical lever position corresponds to the OPEN position and the horizontal position corresponds to the CLOSED position.

Attention! Turning the air damper on or off will not turn the ventilator on or off!

WARTUNGSHINWEISE





DISCONNECT THE UNIT FROM POWER SUPPLY BEFORE ANY MAINTENANCE OPERATIONS!

Maintenance of the ventilator consists in regular cleaning of the surfaces of dust and cleaning or replacement of the filters. To access the main serviced units follow the next steps:

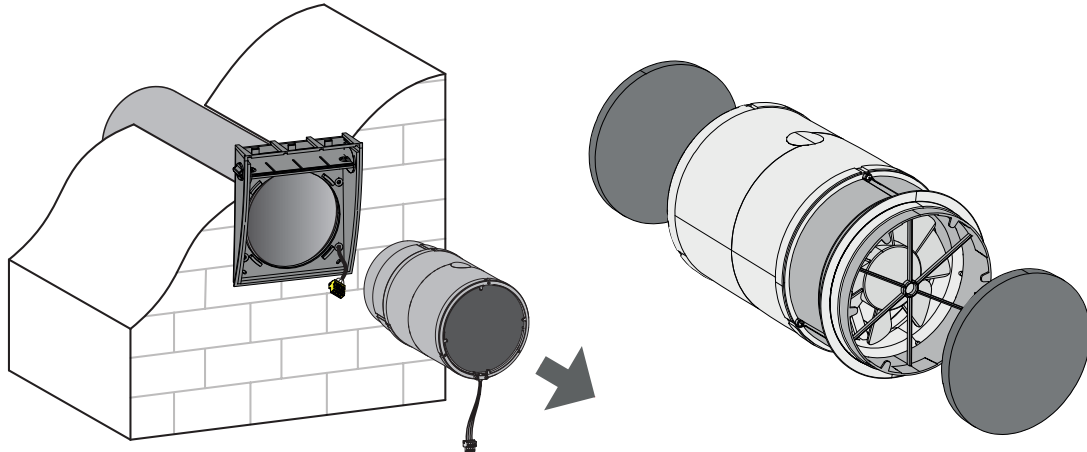
Remove the front panel of the indoor unit, disconnect the connector and pull the cord to remove the cartridge from the air duct. Remove the filters from the cartridge.



Clean the filters according to clogging degree, but at least once in 3 months.

- After completion of the filter timer countdown (90 days) the control panel displays the filter replacement indicator .
- Wash the filters and let those dry out completely. Install the dry filters in the air duct.
- Vacuum cleaning is allowed.
- To reset the filter servicing timer press and hold the  button for 4-5 seconds.
- The filter rated service life is 3 years.
- Contact the Seller for new filters to the ventilator.

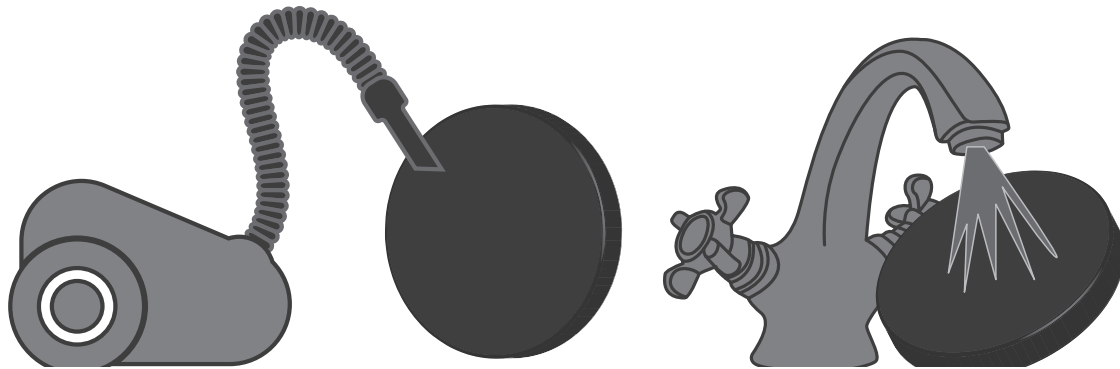

Even regular technical maintenance may not completely prevent dust accumulation on the regenerator and the fan.

- Clean the regenerator regularly to ensure its high heat recovery efficiency.
- Clean the regenerator with a vacuum cleaner at least once in a year.

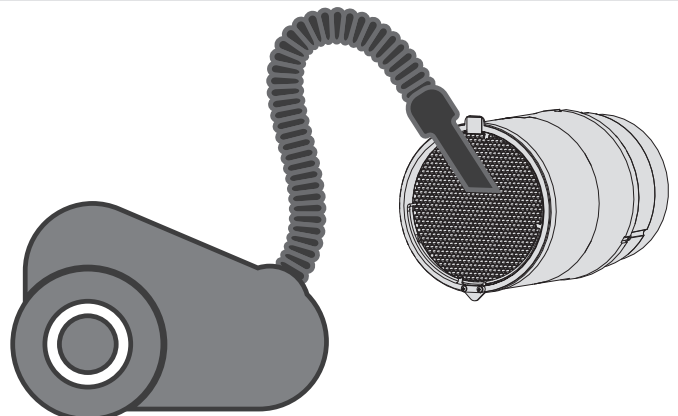

TROUBLESHOOTING

TROUBLES AND TROUBLESHOOTING

Trouble	Possible reasons	Troubleshooting
The fan does not move up during start-up of the unit. The control panel displays no information and does not respond to button pressing.	No power supply.	Contact a qualified electrician to check power supply and troubleshoot a connection error if required.
The alarm indicator  is displayed on the control panel.	Motor jam because of impeller clogging.	Turn the ventilator off. Troubleshoot the impeller clogging. Restart the ventilator.
	Communication loss in the cable connection between the fan motor and control panel.	Turn the ventilator off. Contact the Seller for further information.
Tripping of the circuit breaker during start-up of the ventilator.	Overcurrent as a result of short circuit in the electric circuit.	Turn the ventilator off. Contact the Seller for further information.
Low air flow.	Low set fan speed.	Set higher speed.
	The filter is clogged, the fan or the regenerator is contaminated.	Clean or replace the filter. Clean the fan and the regenerator.
High noise, vibration.	The impeller is contaminated.	Clean the impeller.

STORAGE AND TRANSPORTATION REQUIREMENTS

- Store the unit in the manufacturer's original packaging box in a dry closed ventilated premise with temperature range von +5 °C (+41 °F) bis +40 °C (+104 °F) and relative humidity up to 70 %.
- Storage environment must not contain aggressive vapors and chemical mixtures provoking corrosion, insulation, and sealing deformation.
- Use suitable hoist machinery for handling and storage operations to prevent possible damage to the unit.
- Follow the handling requirements applicable for the particular type of cargo.
- The unit can be carried in the original packaging by any mode of transport provided proper protection against precipitation and mechanical damage. The unit must be transported only in the working position.
- Avoid sharp blows, scratches, or rough handling during loading and unloading.
- Prior to the initial power-up after transportation at low temperatures allow the unit to warm up at operation temperature for at least 3-4 hours.

MANUFACTURER'S WARRANTY

The product is in compliance with EU norms and standards on low voltage guidelines and electromagnetic compatibility. We hereby declare that the product complies with the provisions of Electromagnetic Council Directive 2014/30/EU, Low Voltage Directive 2014/35/EU and CE-marking Directive 93/68/EEC. This certificate is issued following test carried out on samples of the product referred to above. The manufacturer hereby warrants normal operation of the unit for 24 Monaten after the retail sale date provided the user's observance of the transportation, storage, installation, and operation regulations. Should any malfunctions occur in the course of the unit operation through the Manufacturer's fault during the guaranteed period of operation, the user is entitled to get all the faults eliminated by the manufacturer by means of warranty repair at the factory free of charge. The warranty repair includes work specific to elimination of faults in the unit operation to ensure its intended use by the user within the guaranteed period of operation. The faults are eliminated by means of replacement or repair of the unit components or a specific part of such unit component.

The warranty repair does not include:

- routine technical maintenance
- unit installation/dismantling
- unit setup

To benefit from warranty repair, the user must provide the unit, the user's manual with the purchase date stamp, and the payment paperwork certifying the purchase. The unit model must comply with the one stated in the user's manual. Contact the Seller for warranty service.

The manufacturer's warranty does not apply to the following cases:

- User's failure to submit the unit with the entire delivery package as stated in the user's manual including submission with missing component parts previously dismantled by the user.
- Mismatch of the unit model and the brand name with the information stated on the unit packaging and in the user's manual.
- User's failure to ensure timely technical maintenance of the unit.
- External damage to the unit casing (excluding external modifications as required for installation) and internal components caused by the user.
- Redesign or engineering changes to the unit.
- Replacement and use of any assemblies, parts and components not approved by the manufacturer.
- Unit misuse.
- Violation of the unit installation regulations by the user.
- Violation of the unit control regulations by the user.
- Unit connection to power mains with a voltage different from the one stated in the user's manual.
- Unit breakdown due to voltage surges in power mains.
- Discretionary repair of the unit by the user.
- Unit repair by any persons without the manufacturer's authorization.
- Expiration of the unit warranty period.
- Violation of the unit transportation regulations by the user.
- Violation of the unit storage regulations by the user.
- Wrongful actions against the unit committed by third parties.
- Unit breakdown due to circumstances of insuperable force (fire, flood, earthquake, war, hostilities of any kind, blockades).
- Missing seals if provided by the user's manual.
- Failure to submit the user's manual with the unit purchase date stamp.
- Missing payment paperwork certifying the unit purchase.



FOLLOWING THE REGULATIONS STIPULATED HEREIN WILL ENSURE A LONG AND TROUBLE-FREE OPERATION OF THE UNIT.



USER'S WARRANTY CLAIMS SHALL BE SUBJECT TO REVIEW ONLY UPON PRESENTATION OF THE UNIT, THE PAYMENT DOCUMENT AND THE USER'S MANUAL WITH THE PURCHASE DATE STAMP.

CERTIFICATE OF ACCEPTANCE

Unit Type	Heat regeneration single-room reversible ventilator
Model	Twin Fresh Easy Digital V2
Serial Number	
Manufacture Date	
Quality Inspector's Stamp	

SELLER INFORMATION

Seller	
Address	
Phone Number	
E-mail	
Purchase Date	
This is to certify acceptance of the complete unit delivery with the user's manual. The warranty terms are acknowledged and accepted.	
Customer's Signature	

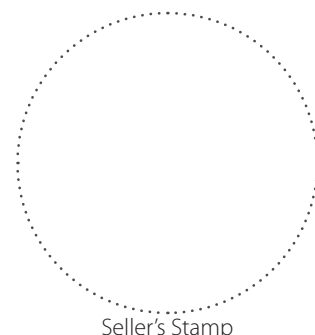

INSTALLATION CERTIFICATE

The TwinFresh Easy _____ unit has been connected to power mains pursuant to the requirements stated in the present user's manual.	
Seller	
Address	
Phone Number	
Installation Technician's Full Name	
Installation Date:	Signature:
The unit has been installed in accordance with the provisions of all the applicable local and national construction, electrical and technical codes and standards. The unit operates normally as intended by the manufacturer.	
Signature:	

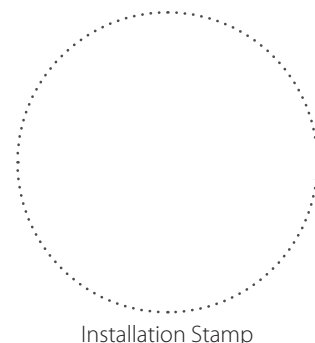

WARRANTY CARD

Unit Type	Heat regeneration single-room reversible ventilator
Model	TwinFresh Easy _____
Serial Number	
Manufacture Date	
Purchase Date	
Warranty Period	
Seller	

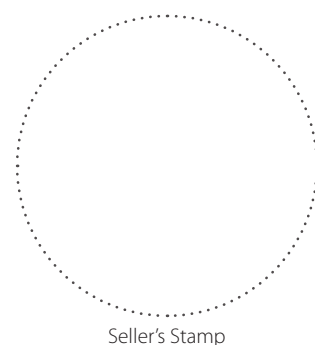



SIKU



SIKU
www.siku.cc

SIKU VertriebsgmbH
Bundesstraße 5
2102 Bisamberg
Austria

Tel.: +43 2262 61 521
Fax: +43 2262 61 520
www.siku.cc
office@siku.cc

